

5 mm x 13 mm x 4 mm ZEN S695-2Z deep groove ball bearings

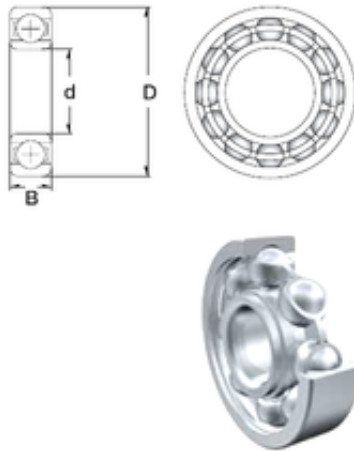

Bearing No. S695-2Z

Size	5x13x4 mm
Bore Diameter	5 mm
Outer Diameter	13 mm
Width	4 mm
d	5 mm
D	13 mm
B	4 mm
C	4 mm
Basic dynamic load rating (C)	1,077 kN
Basic static load rating (C0)	0,432 kN

S695-2Z Bearing 2D drawings and 3D CAD models