

3 mm x 9 mm x 4 mm ZEN MR93-2Z deep groove ball bearings

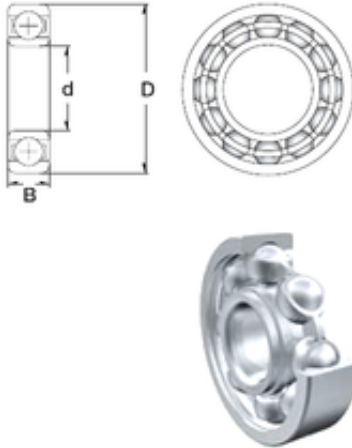

Bearing No. MR93-2Z

Size	3x9x4 mm
Bore Diameter	3 mm
Outer Diameter	9 mm
Width	4 mm
d	3 mm
D	9 mm
B	4 mm
C	4 mm
Basic dynamic load rating (C)	0,571 kN
Basic static load rating (C0)	0,189 kN

MR93-2Z Bearing 2D drawings and 3D CAD models