

ZEN 51100 thrust ball bearings

Bearing No. 51100

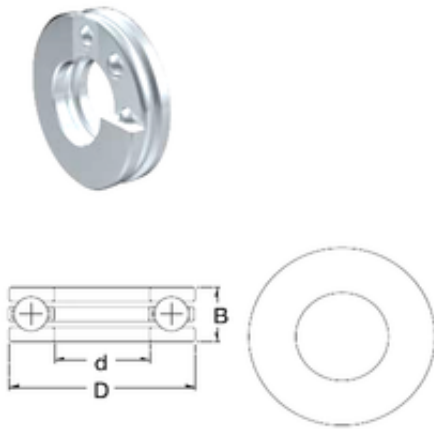

51100 Bearing 2D drawings and 3D CAD models

Size	10x24x9 mm
Bore Diameter	10 mm
Outer Diameter	24 mm
Width	9 mm
d	10 mm
D	24 mm
H	9 mm
Basic dynamic load rating (C)	8,71 kN
Basic static load rating (C0)	8,8 kN
(Grease) Lubrication Speed	7500 r/min